

SEGUIDOR SOLAR A DOS EJES SHS.345C

PARA ENERGIA SOLAR DE CONCENTRACION

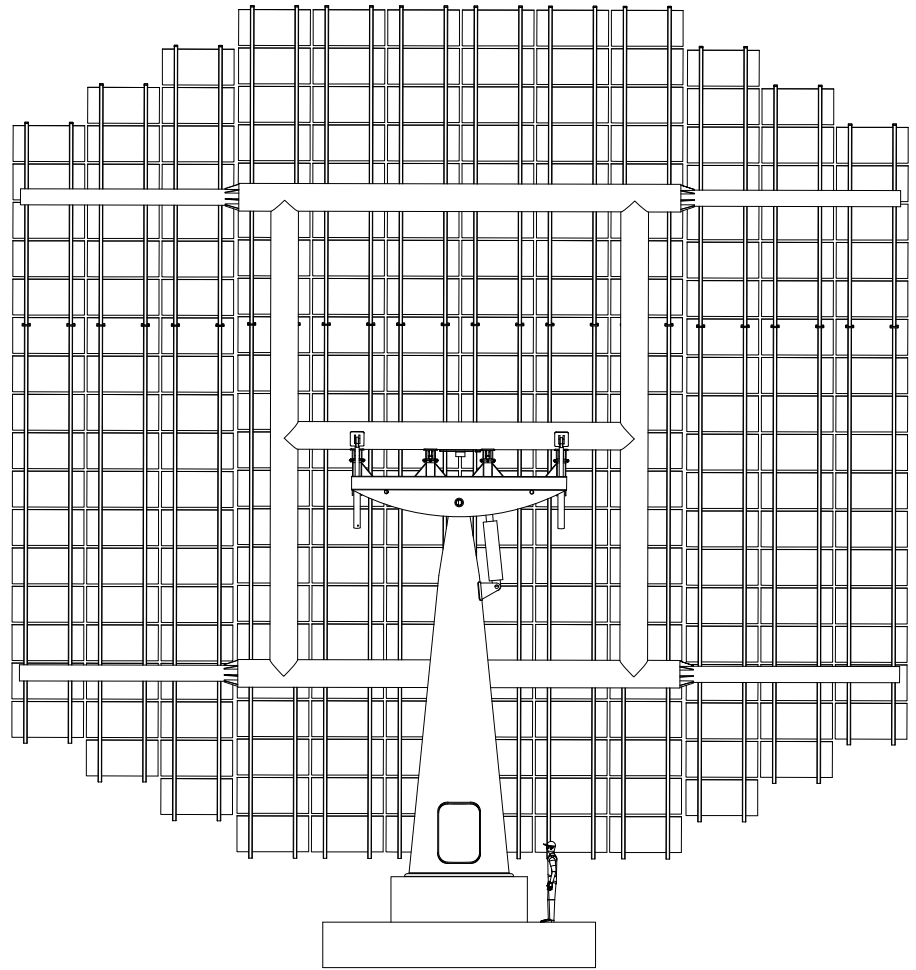

POSICIÓN DE NACIENTE

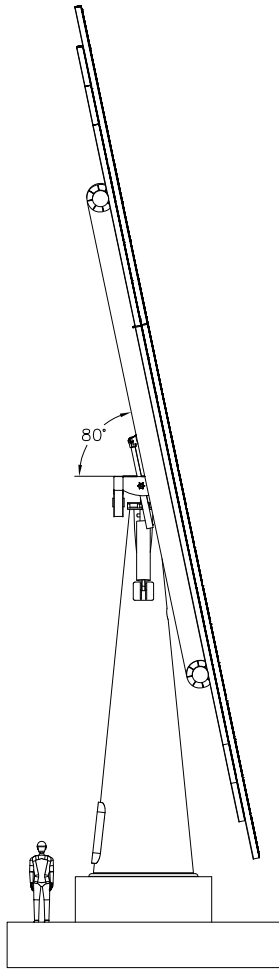
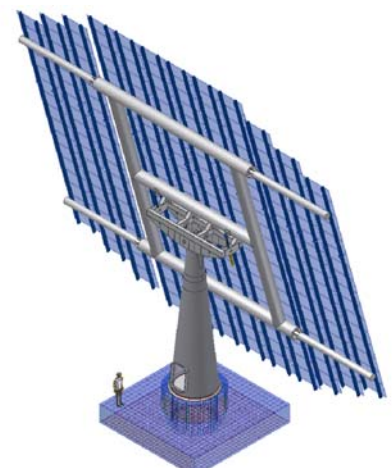
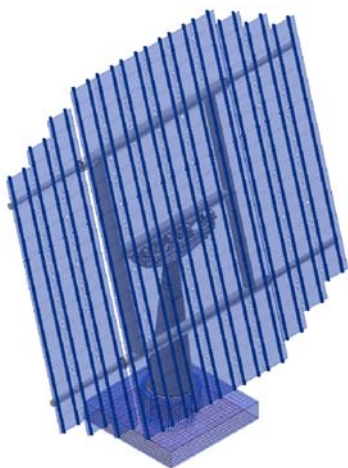

SEGUIDOR SOLAR A DOS EJES SHS.345C

PARA ENERGIA SOLAR DE CONCENTRACION

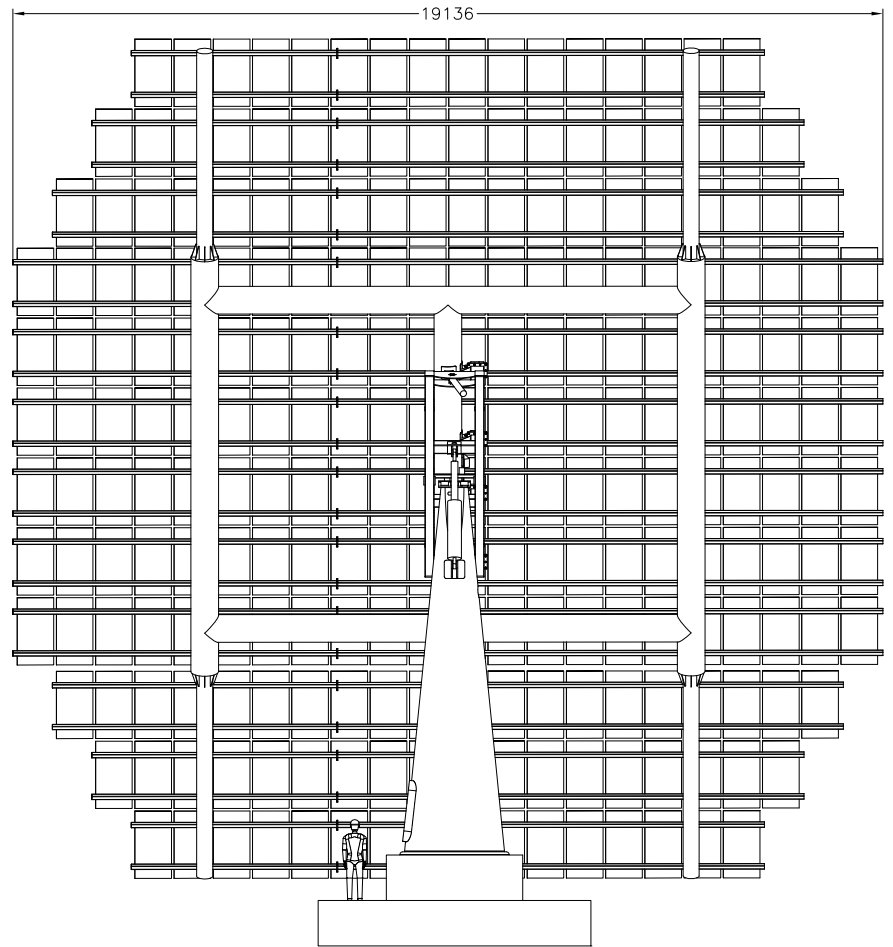
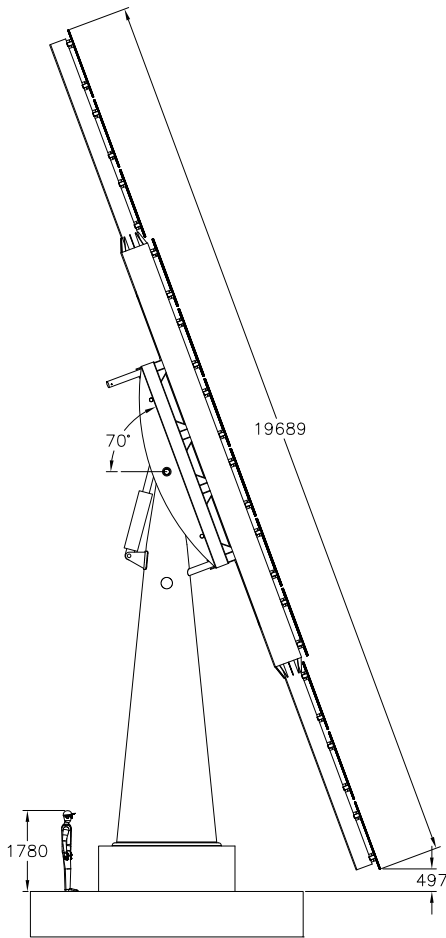

POSICIÓN DE MEDIODIA

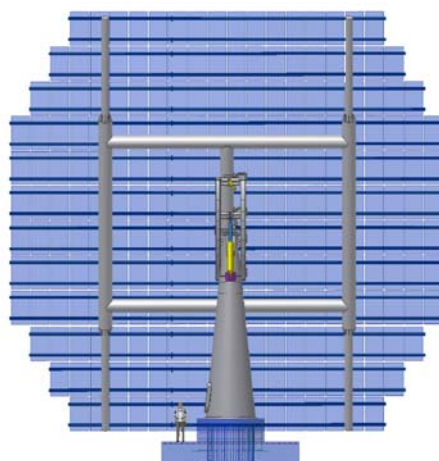
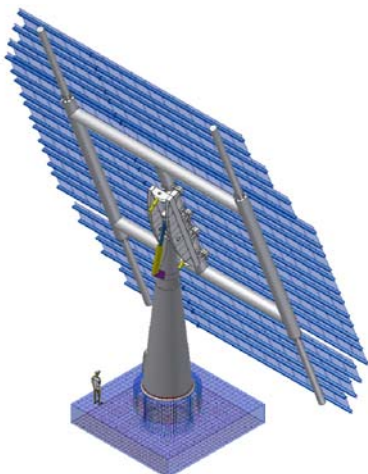

SEGUIDOR SOLAR A DOS EJES SHS.345C

PARA ENERGIA SOLAR DE CONCENTRACIÓN

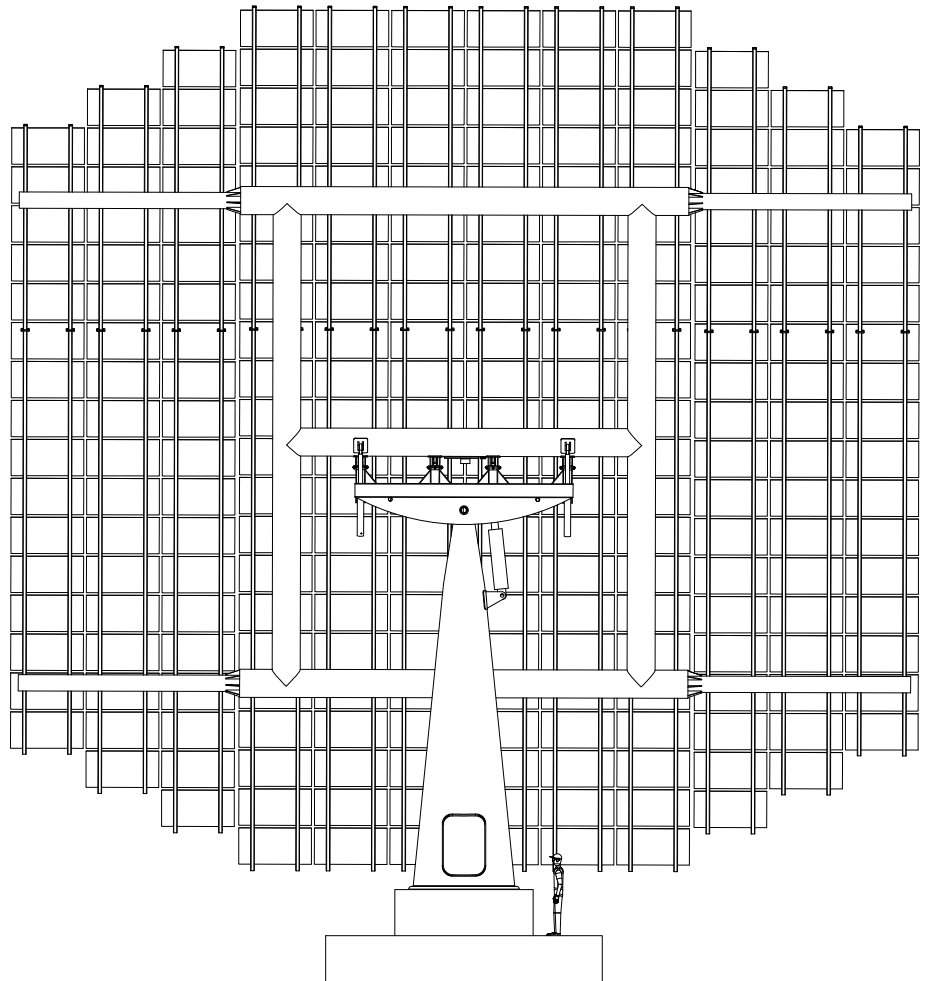
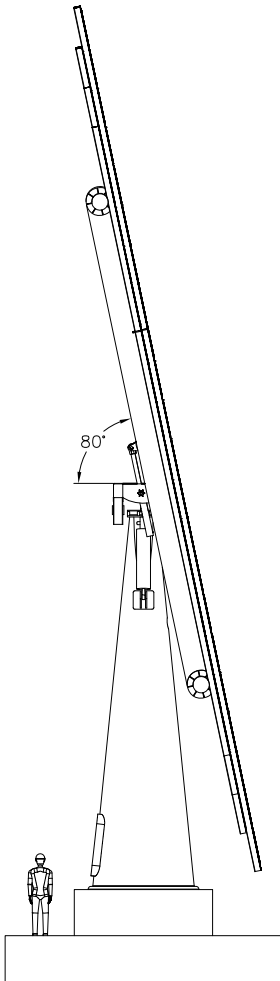

POSICIÓN DE PONIENTE

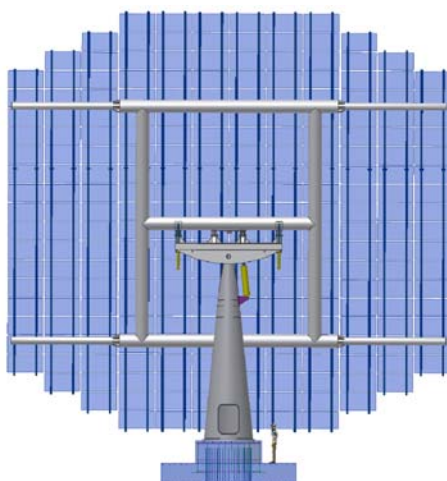
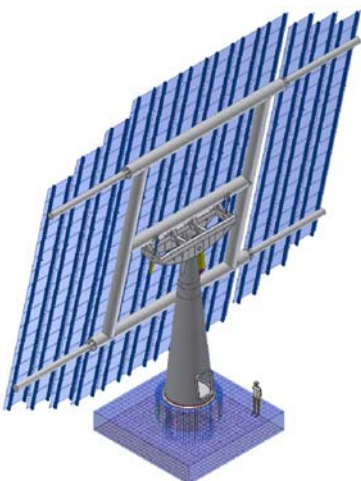

SEGUIDOR SOLAR A DOS EJES SHS.345C PARA ENERGIA SOLAR DE CONCENTRACIÓN

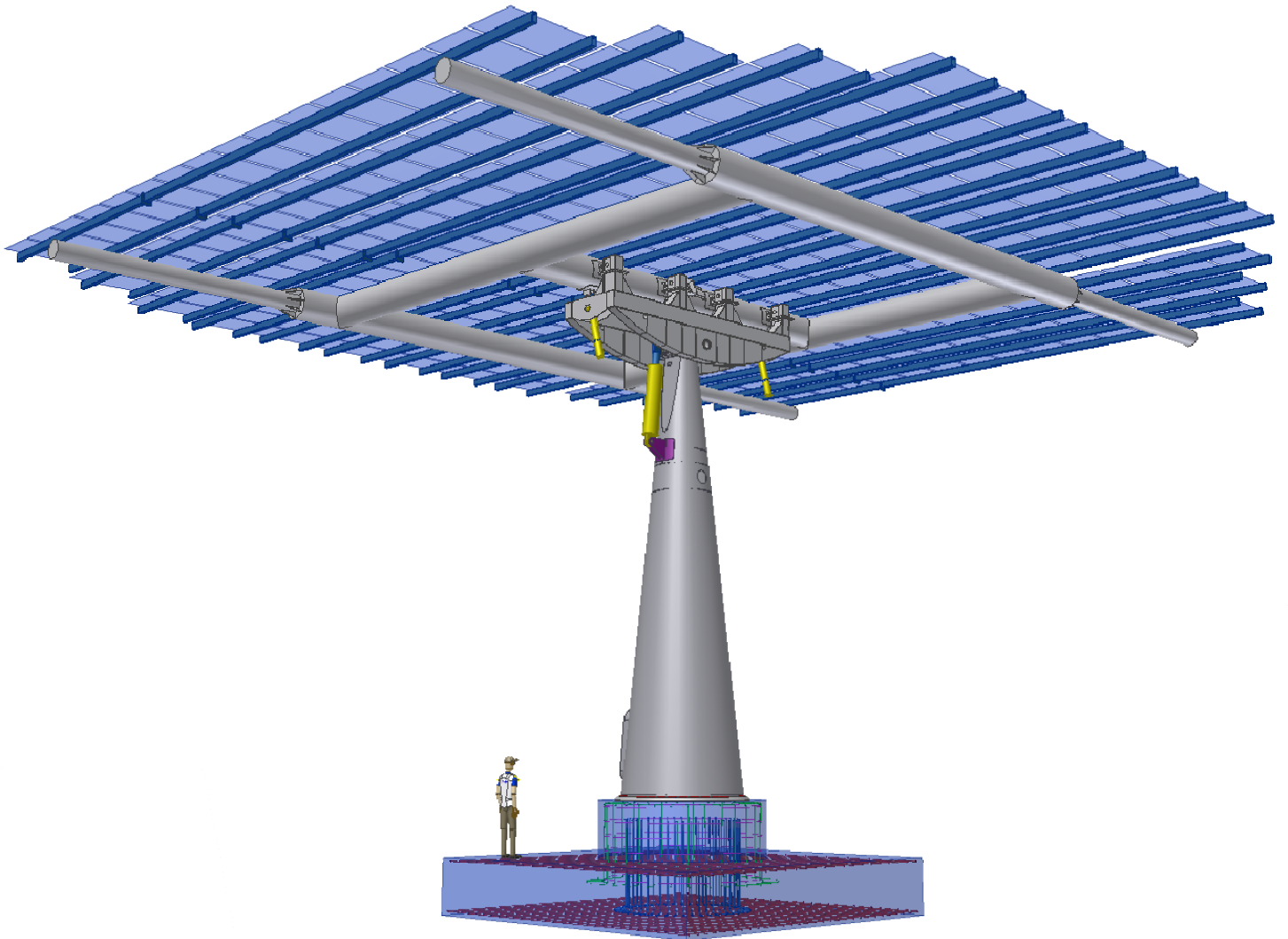

POSICIÓN DE SEGURIDAD O NOCTURNA

